

# RQ-7 UAV

United States ARMY

1:12 Scale

2013 | 01

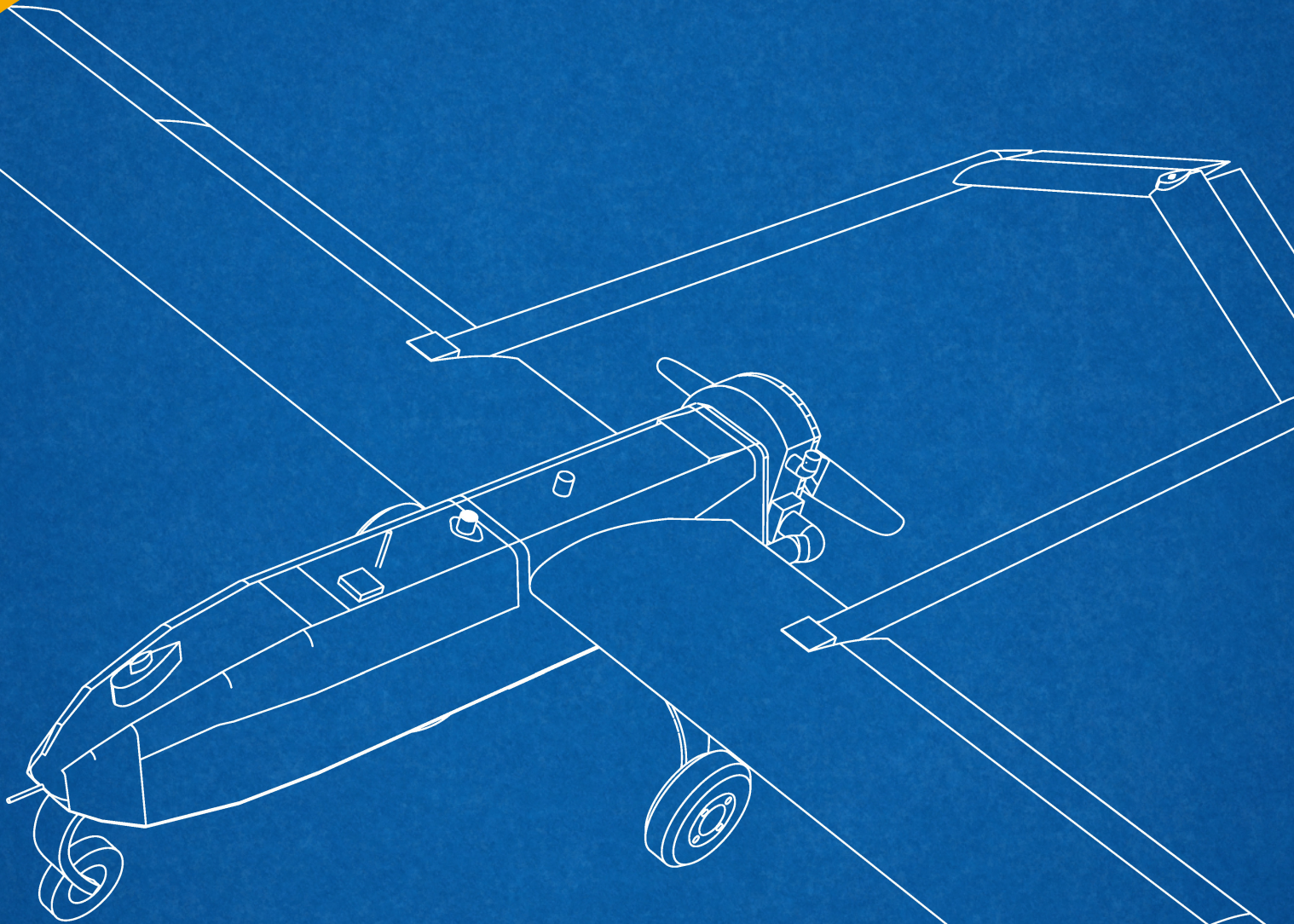

# RQ-7 UAV U.S.ARMY 1:12

## Assembly

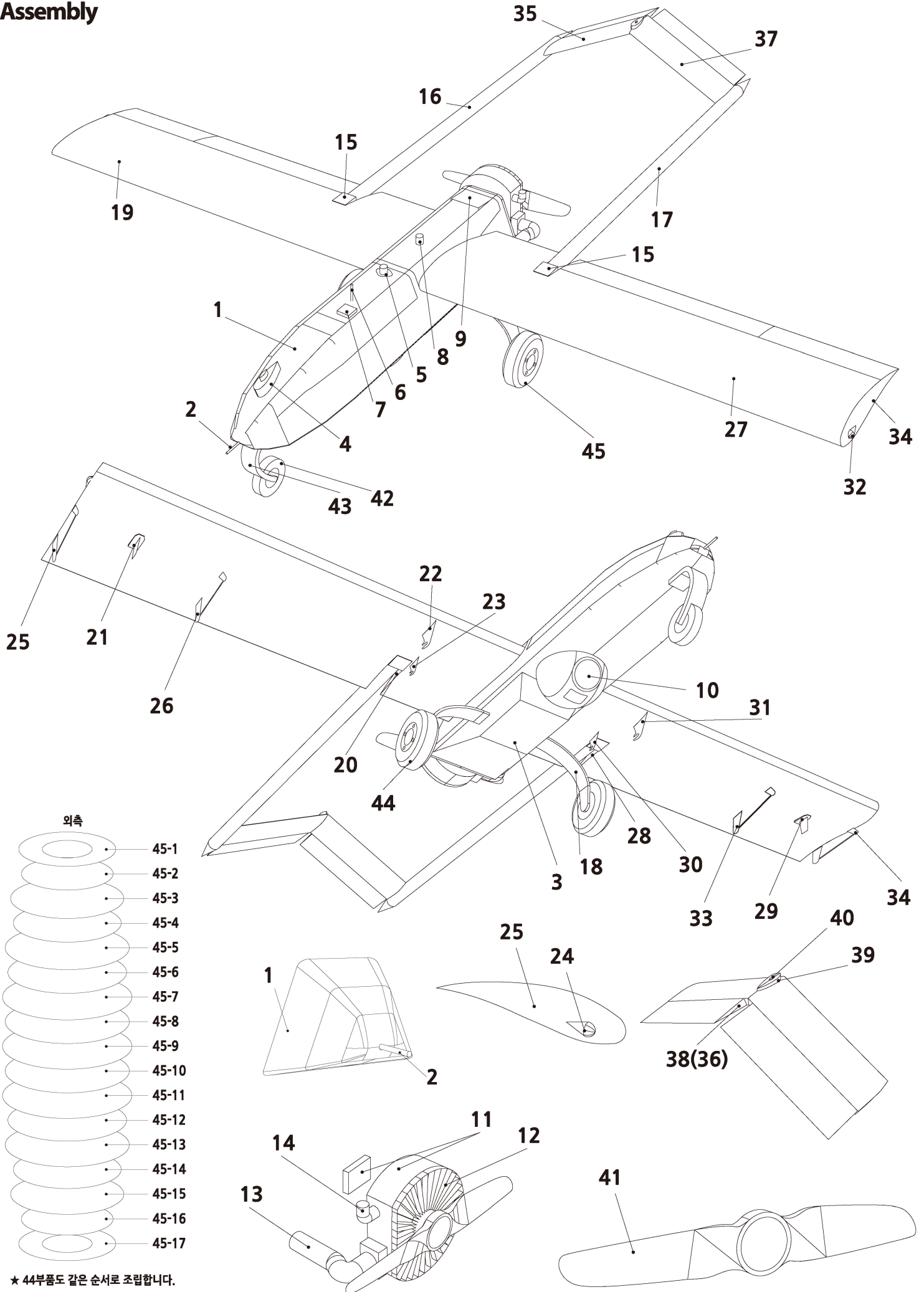



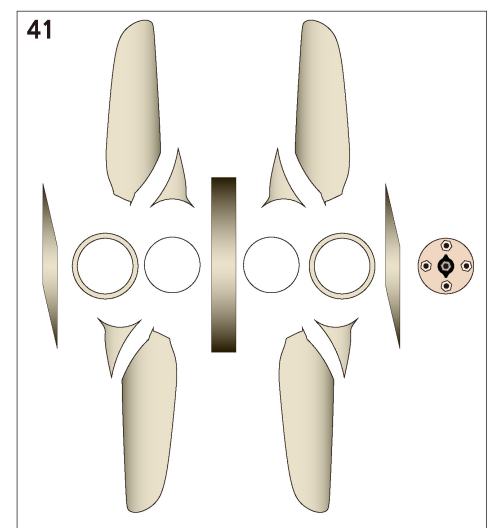
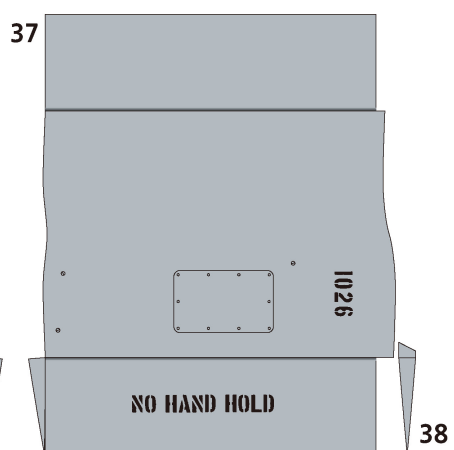
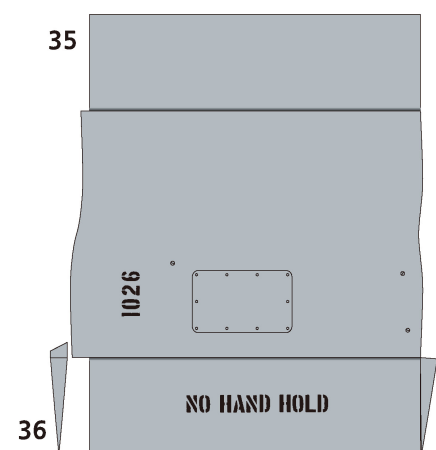
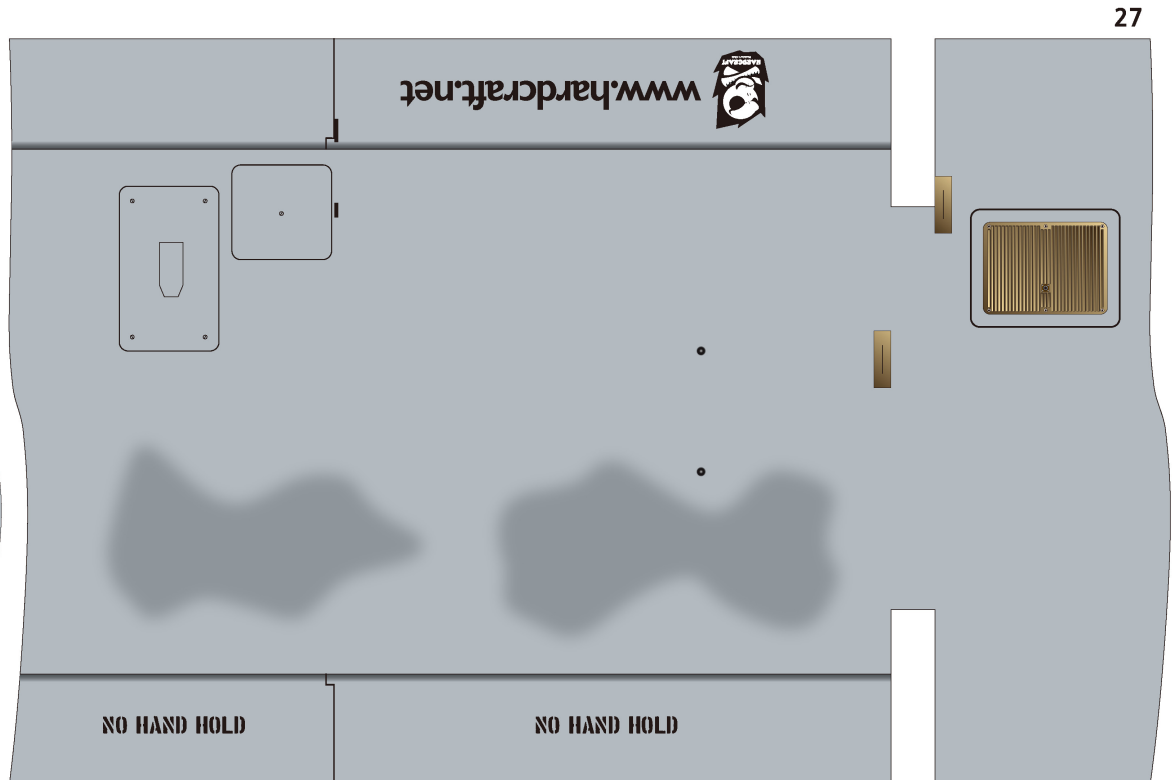
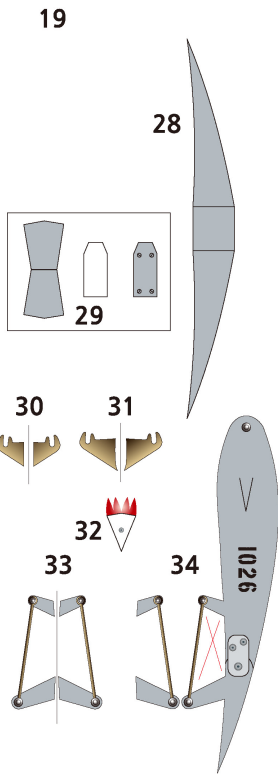
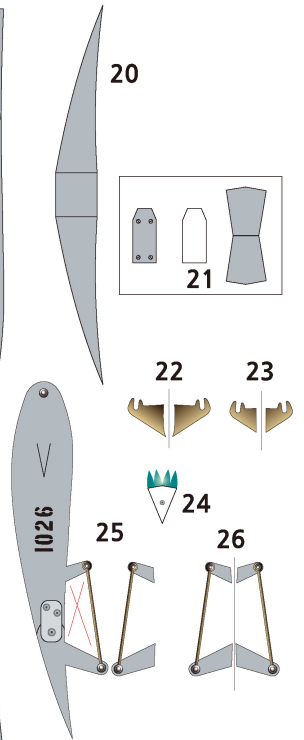
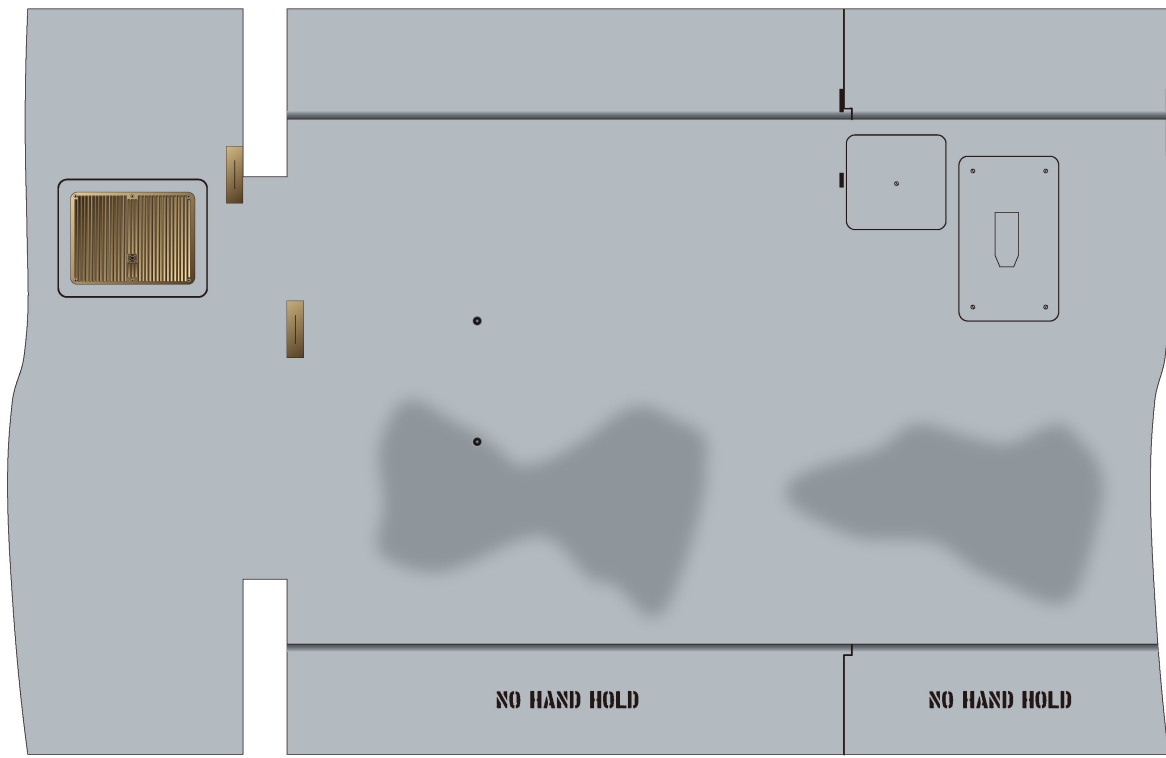



42

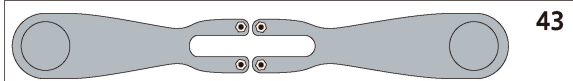

43

조립 참고 각도 및 두께

이 부품은 0.8mm 보드를 한 장만 합지하세요.

18

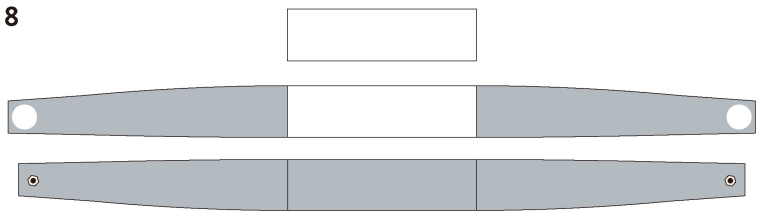

조립 참고 각도 및 두께  
이 부품은 0.8mm 보드를 한 장만 합지하세요.

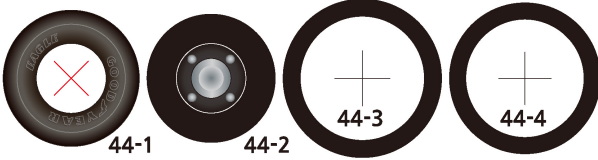

44-1

44-2

44-3

44-4

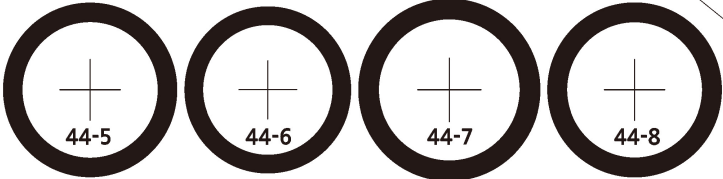

44-5

44-6

44-7

44-8

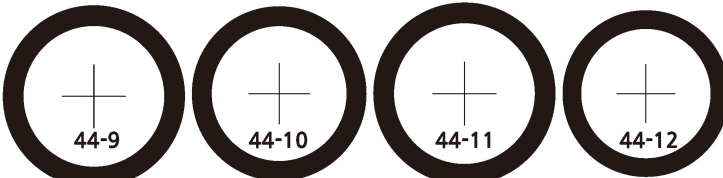

44-9

44-10

44-11

44-12

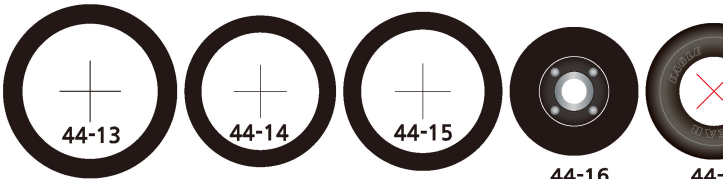

44-13

44-14

44-15

44-16



44-17

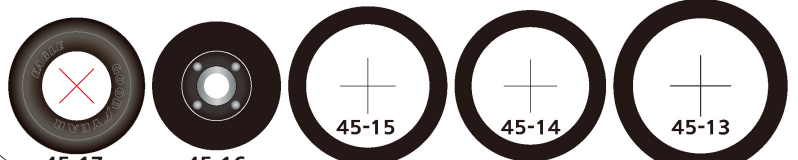

45-17

45-16

45-15

45-14

45-13

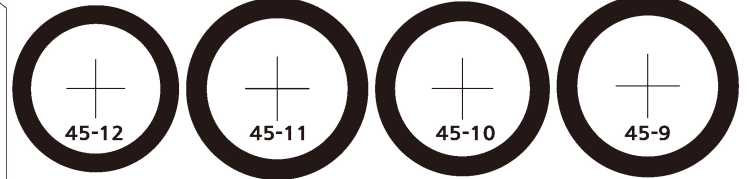

45-12

45-11

45-10

45-9

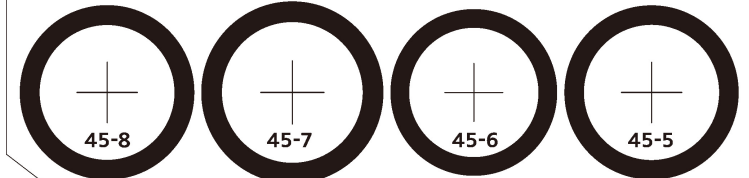

45-8

45-7

45-6

45-5



45-4

45-3

45-2

45-1

이 부품들은 0.8mm 보드를 합지하세요.

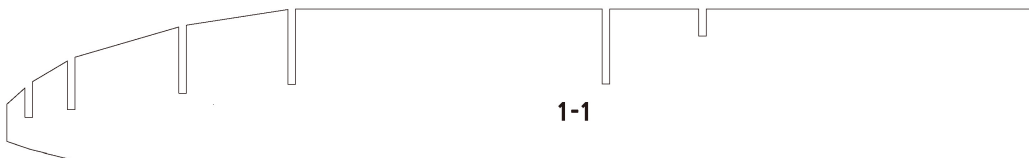

1-1

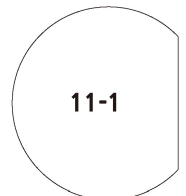

11-1

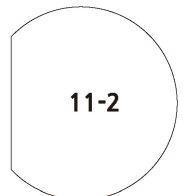

11-2

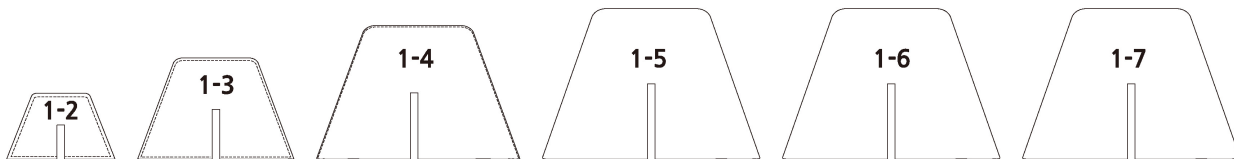

1-2

1-3

1-4

1-5

1-6

1-7

41-1

41-2



Body

19-1



1-8



Body

27-1



19-2

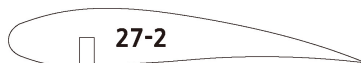

27-2

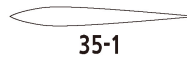

35-1



19-3

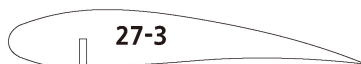

27-3

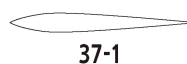

37-1



19-4

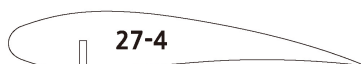

27-4



42-1



42-2